

Product HV Gate Valve with manual actuator

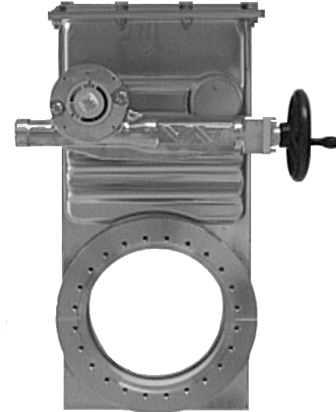

This manual is valid for the valve ordering number(s):

- 14036- . E01/06/07/08
- 14038- . E01/06/07/08
- 14040- . E01/06/07/08
- 14044- . E01/06/07/08
- 14046- . E01/06/07/08
- 14048- . E01/06/07/08
- 14050- . E01/06/07/08
- 14052- . E01/06/07/08

The fabrication number is indicated on each product as per the label below (or similar):

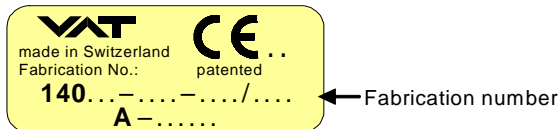

Explanation of symbols:



Read declaration carefully before you start any other action!



Keep body parts and objects away from the valve opening!



Attention!



Hot surfaces; do not touch!



Product is in conformity with EC guidelines, if applicable!



Loaded springs and/or air cushions are potential hazards!



Disconnect electrical power and compressed air lines. Do not touch parts under voltage!



Wear gloves!



Read these «**Installation, Operating & Maintenance Instructions**» and the enclosed «**General Safety Instructions**» carefully before you start any other action!



Installation, Operating, and Maintenance Instructions
Series 14, DN 63 - 400 (I.D. 2 1/2 - 16")

Imprint:

Manufacturer VAT Vakuumventile AG, CH-9469 Haag, Switzerland

Website
www.vatvalve.com

Phone
+41 81 771 61 61

Fax
+41 81 771 48 30

Email
CH@vatvalve.com

Publisher VAT Vakuumventile AG, CH-9469 Haag, Switzerland

Editor VAT Vakuumventile AG, CH-9469 Haag, Switzerland

Print VAT Vakuumventile AG, CH-9469 Haag, Switzerland

Copyright © VAT Vakuumventile AG 2008

No part of these Instructions may be reproduced in any way (photocopies, microfilms or any other reproduction processes) nor may it be manipulated with electronic systems, duplicated or distributed without written permission from VAT. Offenders are liable to pay damages.

The original VAT firmware and updated state of the art versions of the VAT firmware are intended for use with VAT products. The VAT firmware contains a limited, time unlimited user license. The VAT firmware may not be used for purposes other than those intended nor is it permitted to make copies of the VAT firmware. In particular, it is strictly forbidden to give copies of the VAT firmware to other people.

The use of trade names, brand names, trademarks, etc. in these Instructions does not entitle third parties to consider these names to be unprotected and to use them freely. This is in accordance with the meaning of the laws and acts covering brand names and trademarks.



Contents:

1	Use of product	4
1.1	Technical data	4
2	Installation.....	5
2.1	Unpacking	5
2.2	Installation into the system.....	5
2.3	Admissible forces and bending moment	6
2.4	Connections	7
2.4.1	Electrical connection	7
3	Operation	7
3.1	Normal operation.....	7
3.2	Operation under increased temperature	7
3.3	Differential pressure	7
4	Trouble shooting	8
5	Maintenance & repairs	9
5.1	General maintenance instruction	9
5.2	Preventive maintenance.....	10
5.3	Safety instruction.....	11
5.4	Maintenance of assemblies.....	12
5.4.1	Preparing valve maintenance	12
5.4.2	replacing of gate seal / mechanism / bonnet seal.....	12
5.4.3	Replacing of ball bearings 11 on mechanism	13
5.4.4	Disassembling of mechanism / replacing of locking balls.....	13
5.4.5	Dismantling and mantling of actuator.....	14
5.4.6	Dismantle of rotary feed through and replacing the feed through seals	15
6	Drawing.....	16
6.1	Valve Assembly.....	16
6.2	Mechanism assembly.....	17
7	Spare parts	20
8	Warranty	21



1 Use of product

Use product for clean and dry indoor vacuum applications under the conditions indicated in chapter «Technical data» only!
Other applications are only allowed with the written permission of VAT.

1.1 Technical data

Pressure range	DN 63 - 200	1 x 10 ⁻⁸ mbar to 2 bar (abs)
	DN 250 - 400	1 x 10 ⁻⁸ mbar to 1.2 bar (abs)
Differential pressure on the gate	DN 63 - 200	≤ 2 bar in either direction
	DN 250 - 400	≤ 1.2 bar
Max. differential pressure at opening		≤ 30 mbar
Admissible temperature:	Valve	≤ 150°C
	Manual actuator	≤ 80°C

Further data according to newest VAT catalogue «Vacuum Valves».

2 Installation

2.1 Unpacking

Make sure, that the delivered components are according to the order.

Visually check the quality of the components.

If some element of the delivery is not as expected please contact VAT immediately.

Notice:

Please do not throw away the original packaging. Packaging may be useful in future should the components be returned to VAT.



Check immediately after receiving and unpacking the valve ,

- that the delivered components are corresponding with the order!
- regarding quality!
- regarding quantity!

Please do not throw away the original packaging. Packaging may be useful in future should the components be returned to VAT.

Open package box cautiously to avoid any damages on product. Lift the valve out off package with appropriate equipment. Fix the lifting straps on the installed eye bolts (the dimensional drawing indicates the eye bolts with ). Lift the crane hook slowly until the straps are under tension. Keep lifting the hook and move the hook step by step until the valve is in vertical position. Lift the valve out off the box and move it slowly to the mounting chamber flange.



ATTENTION: HEAVY LOAD!
use especially for larger valves a lifting aid (crane or any similar)

ATTENTION: Do not lift the valve at actuator.
Attach the lifting ropes to the lifting elements (the dimension drawing indicates to the eye bolts with .

2.2 Installation into the system

The valve seat side is indicated by the symbol "▽" on the connection flange.

Preparation for mounting the valve to the system

1. Clean the sealing surface and the O-ring seal of the mating flange.
2. Move the gate valve into the correct mounting position with the crane.
ATTENTION: Do not hit the sealing surfaces while maneuvering into position!
3. Offer valve to first the flange and initially and hold in position using two bolts opposite each other.
4. Further securing using two additional bolts inserted around from the first two bolts.
5. Fasten the 4 bolts crosswise until the O-ring seal makes contact with the valve sealing surface.
6. Apply all remaining screws
7. Fasten all screws gradually in crosswise order.

2.3 Admissible forces and bending moment

Evacuating the system, the weight of assemblies or heating causes forces which can affect the appropriate functionality of the valve. Such forces have to be eliminated by means of compensating them or proper reinforcements. The following forces are admissible:

DN (nom. I.D.)		Axial traction or pressure force «FA»		Bending moment «M»	
mm	inch	N	lbf	Nm	lbf · ft
63	2½	1960	440	78	58
80	3	1960	440	78	58
100	4	2450	560	98	72
160	6	2940	660	147	108
200	8	2940	660	147	108
250	10	3430	770	196	145
320	12	3920	880	294	217
350	14	3920	880	294	217
400	16	7840	1760	980	722

In case of both kind of forces are occurring («FA» und «M»), the above shown values are invalid. Please contact VAT in this case.

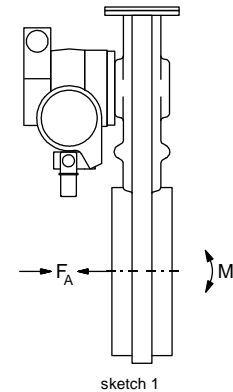

Table 1

2.4 Connections

2.4.1 Electrical connection



Do not touch electrical parts under voltage!



Connect electrical power only if
 - valve has been installed into the vacuum system
 - moving parts cannot be touched

The socket for the position indicator is supplied with the valve.

Wire the position indicator according to the diagram opposite:

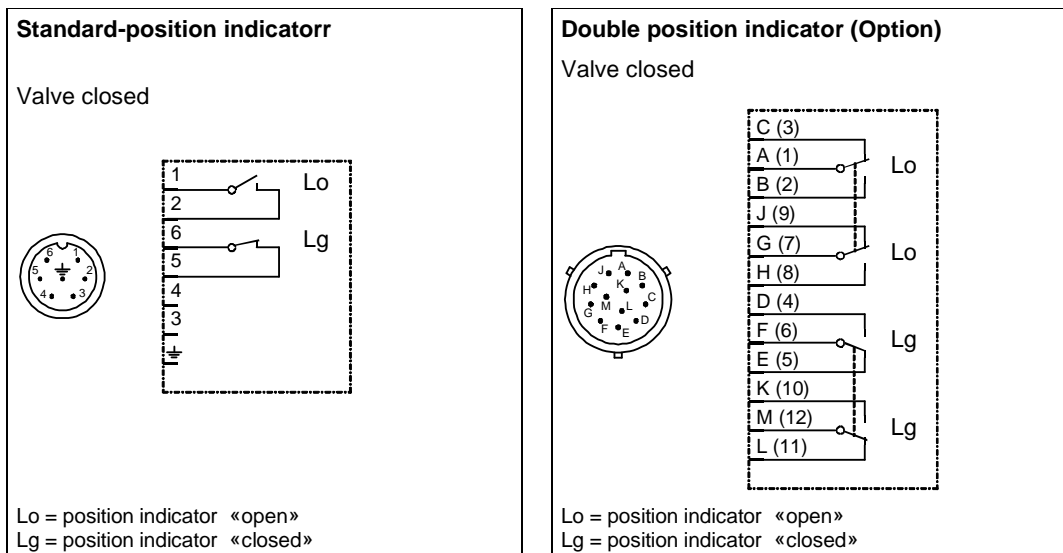

Figure 1

3 Operation

3.1 Normal operation

Valve is opened and closed by means of a manual spindle.

3.2 Operation under increased temperature

See «1.1 Technical data»

3.3 Differential pressure

See 1.1 «Technical data»!



4 Trouble shooting

Failure	check	remedy
Leak on gate :	Is the valve locked properly?	Check position indicator for closed Position.
	Is seat sealing surface and/or gate soiled or damaged?	Clean or replace gate seal in case of any damage! If the sealing surface is damaged contact the nearest VAT service centre .
Leak on body:	Are the body flanges on interface surfaces leak tight? Fastening torque OK?	Fasten bolts according chapter 2.3!
	Are the admissible forces OK?	Check according chapter . 2.4 !
	Any dirt or soil ?	Clean sealing surfaces and seals!
	Damages onto sealing surface ?	Contact the nearest VAT service centre!
	Is there a leak at rotary feed through?	Use provided hole on feed through for leak detecting! Contact the nearest VAT service centre!
Leak at bonnet seal?	Clean bonnet seal or replace it in case of any damages. If the sealing surface is damaged contact the nearest VAT service centre!	

Table 2

If you need any further information, please contact one of our service centers. You can find the addresses on our website: <http://www.vat.ch>



5 Maintenance & repairs

Under clean operating conditions, the valve does not require any maintenance during the specified cycle life. Contamination from the process may influence the function and requires more frequent maintenance.

Before carrying out any maintenance or repairs, please contact VAT. It has to be individually decided whether the maintenance/repair can be performed by the customer or has to be carried out by VAT. The fabrication number on the valve

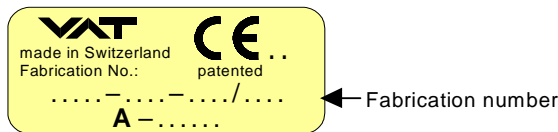

has always to be specified.

All supplies (e. g. compressed air, electrical power) must be disconnected for removal/installation of the valve from/into the system and for maintenance work.



Even with disconnected supply, loaded springs and/or air cushions in cylinders can be potential hazards.



Keep fingers and objects away from the valve opening!

Products returned to VAT must be free of harmful substances such as e.g. toxic, caustic or microbiological ones. If products are radioactively contaminated, fill in the VAT form «Contamination and Radiation Report» and send it with the product. The form is available at VAT. The maximum values indicated in the form must not be exceeded.

5.1 General maintenance instruction

Under clean operating conditions, the valve does not require any maintenance during the specified cycle life.

Note! Process has influence to the suggested maintenance interval and can shorten it. (e.g. due to corrosive gases or accumulation to the inner parts of valve)

To minimise downtime and expenditure of equipment you can replace the whole mechanism by a spare mechanism

Attention! Never loosen or readjust adjusting plate (X)! (see chapter 6)

5.2 Preventive maintenance

For clean vacuum application VAT suggests preventive maintenances after 200'000 cycles ¹

The numbers in brackets are referring to drawing in chapter 6

- clean gate o-ring and sealing surfaces
- investigate bonnet seal (3), ball bearings (11) on mechanism and crank bolt (6) for signs of wear. Clean or re-lubricate or replace them if necessary (see chapter 7 spare parts)
- replace all parts showing corrosions, accumulations or signs of wear (see chapter 7 spare parts)

General

signs of wear →	Replace part
dust or dirt →	Clean part and re-lubricate it





When cleaning parts always dismantle them according to chapter 5.4 and clean the single parts only.

Never put whole assemblies into the cleaning bath

Always lubricate parts accordingly or use VAT lubricated spares !

¹ The mentioned cycles are invalid for DN400 in vertical mounting position

5.3 Safety instruction

	<p>CAUTION : risk of injury</p> <p>RISK of dropping mechanism</p> <p>RULES for accident prevention: If the valve is installed in a vertical position (bonnet up) it is possible that when dismantling the crank bolt (6) step 5 (see below) that the mechanism can drop due to the force of gravity. Therefore absolutely consider the size of valve and consequently the weight of mechanism</p>
	<p>CAUTION : risk of injury</p> <p>RISK of catapulting parts</p> <p>RULES for accident prevention: The actuation may only dismantled by authorized and trained staff! If you dismount the actuation and cylinder cover respectively for replacing the pneumatic seals pay attention that the circlip does not jump out of the groove. When reassembling the circlip make sure that it is mounted and fixed in to the groove properly Inappropriate mounting of circlip can catapult out the cover when actuating the valve. This is potentially a CONSIDERABLE RISK of injury.</p>
	<p>CAUTION : risk of injury</p> <p>RISK of electro shock</p> <p>RULES for accident prevention: DISCONNECT valve while maintaining it</p> <ol style="list-style-type: none">1. vent the vacuum chambers on both sides up to atmospheric pressure.2. open the valve.3. switch off compressed air supply.4. switch off power supply.5. disconnect compressed air and power supply from valve. <p>Always carry out the Steps 1 to 5 before maintaining a valve.</p>



5.4 Maintenance of assemblies

5.4.1 Preparing valve maintenance

Provide a clean working space for assembling and storage for dismantled parts.

5.4.2 replacing of gate seal / mechanism / bonnet seal

The numbers in brackets are referring to drawing in chapter 6

Tip:

Provide a clean working space for assembling and storage for dismantled parts. .

1. **Before dismantling the valve please read the safety instructions in chapter 5.3**
2. Undo bolted joint (1) from bonnet flange (2)
3. Put bonnet seal and bonnet onto a clean working space.
4. Move mechanism by means of manual operation to «open» position
5. Remove screw (5)
6. Remove crank bolt (6) (if required lift mechanism slightly .)
7. Draw mechanism out of valve body carefully and put it onto a clean working
Attention: Do not damage mechanism! (disassembling of mechanism see chapter 5.4.4)
8. Take out gate O-Ring (4) from o-ring groove
Attention: Do not damage the sealing surface on groove bottom!
9. Dismantle mechanism in single parts or assemblies (disassembling of mechanism see chapter 5.4.4)
Attention: do not loosen adjusting plate (X)!
10. Clean mechanism in an appropriate way
Attention: after cleaning, grease have to be removed or ineffective !
11. Assemble mechanism again
Attention: use new locking balls (10), ball bearings / leaf springs (11) or/and crank bolt (6)!
(these parts always lubricated with **VAT High vacuum grease**)
12. Clean and check grooves and sealing surfaces properly
13. Install a new gate o-ring (4)
Attention: press o-ring evenly and simultaneously on opposite side (diagonal) in to the groove!
14. Mount the mechanism to the valve body cautiously.
15. Install crank bolt (6)
16. Mount bolt (5) and tighten it
17. Move mechanism by hand in closing direction
18. Place bonnet seal (3) and bonnet (2)
19. Tighten bolt (1) on bonnet flange (2) uniformly and on opposite side (diagonal) ,
20. Torque :
DN 63 - 100 10 Nm / 8 lbf · ft
DN 160 - 400 18 Nm / 13 lbf · ft
21. Connect power
22. Connect compressed air
23. Carry out function and leak test
24. Valve is ready to operate



5.4.3 Replacing of ball bearings 11 on mechanism

The numbers in brackets are referring to drawing in chapter 6

Tip:

Provide a clean working space for assembling and storage for dismantled parts.

- DN 160 - 200: replace complete leaf spring (11) including two ball bearings

Attention: after unscrewing the threaded studs on gate have to be lubricated with **VAT High vacuum grease** slightly! This avoids seizing of nuts to the bolts.

- DN 250 - 400: replace the ball bearings singly

Attention: lubricate slightly the trunnion or the nut with **VAT High vacuum grease** after unscrewing it! This avoids seizing of nut to the trunnion.

5.4.4 Disassembling of mechanism / replacing of locking balls

The numbers in brackets are referring to drawing in chapter 6.2

Tip:

Prepare a clean working space for assembling and storage for dismantled parts.

DN 63 and 100 (see chapter 6.2)

1. **Before dismantling the valve please read the safety instructions in chapter 5.3**
2. Put mechanism carefully onto a clean working space with the seat side downwards
3. push leaf spring and centre ring down slightly and take out the divided circlip off the leading centre bolt groove
4. lift off leaf spring and centre ring.
5. keep gate and ball guidance together properly and turn over the mechanism. Put it with the ball guidance downward onto the working space.
6. Take off the gate and put it with the sealing side downwards onto the working space.
7. Now take out the locking balls and clean or replace them if necessary.
Attention:
when replacing the locking balls
the locking balls of spare parts kit (see chapter 7 table item 10) are lubricated from VAT side with **VAT High vacuum grease** already
When cleaning the locking balls
If cleaning the locking balls lubricate them with **VAT High vacuum grease** afterwards!
8. clean the ball guidance
9. clean the ball tracks
10. put the locking balls into the ball guidance again.
11. set the gate onto the ball guidance again
Attention: pay attention that the joint of guidance is positioned in the right way (see drawing chapter 6.1 and 6.2)
12. Mount the leaf spring in reverse way as described above (see 3)
Attention: lubricate the nuts and studs with **VAT High vacuum grease** slightly (seizing)!

DN 160 to 400 (see chapter 6.2)

1. **Before dismantling the valve please read the safety instructions in chapter 5.3**
2. Put mechanism carefully onto a clean working space with the seat side downwards
3. remove the 4 and 6 nuts respectively holding the leaf springs



4. take out the leaf springs
5. take off counter plate
6. take out above laying locking balls and put in onto working space
7. lift off ball guidance
8. take out the beneath locking balls from recess` and put it on the working space
9. Now you can clean or replace the locking balls

Attention:

when replacing the locking balls

the locking balls of spare parts kit (see chapter 7 table item 10) are lubricated from VAT side with **VAT High vacuum grease** already

When cleaning the locking balls

If cleaning the locking balls lubricate them with **VAT High vacuum grease** afterwards!

10. clean the ball guidance
11. clean the ball tracks of gate an counter gate.
12. put the locking balls into the recess of gate again.
13. insert the lubricated locking balls into the ball tracks of gate again.
14. set the ball guidance onto the gate and install the locking balls
Attention: pay attention that the joint of guidance is positioned in the right way (see drawing chapter 6.1)
15. set the counter gate onto the ball guidance
Attention: pay attention that the counter gate is positioned in the right way
16. mount on the leaf spring in opposite way like described above (see 4 to 1)
Attention: lubricate the nuts and studs with **VAT High vacuum grease** slightly (seizing)!

5.4.5 Dismantling and mantling of actuator

The numbers in brackets are referring to drawing in chapter 6

1. Move valve to closed position
2. Remove position indicator housing (4 screws)
3. Open and remove two hexagon screws fixing the actuation
4. Withdraw actuation from gear wheel of rotary feed through.
5. For remounting the actuation again bring it in closed position
Attention: Valve with actuation in position A the piston rod has to be in extended position!
Valve with actuation in position B the piston rod has to be in retracted position!
6. For mounting the actuation the valve has to be in closed and locked position. For closing and locking the valve use a proper flat wrench and turn at the four cornered shaft (X) of rotary feed through.
7. Set the actuator onto the pinion of rotary feed through with out tilting. If it is not possible to stick through the bolts turn the actuation slightly counter clockwise
8. Fasten the bolts
9. Mount position indicator again.



5.4.6 Dismantle of rotary feed through and replacing the feed through seals

Dismantle of rotary feed through and replacing the feed through seals (14)

The numbers in brackets are referring to drawing in chapter 6

Preparation :

1. dismantle the mechanism like described above.
2. dismantle the actuator like described above.

Dismounting of rotary feed through:

1. take out safety splint pin (12) and remove the lever.
2. unscrew the two screws of rotary feed through.
3. take out the rotary feed through and replace O-ring (14)
Attention: lubricate the o-ring with **VAT High vacuum grease** slightly!
4. mount the rotary feed through in reverse order

6 Drawing

6.1 Valve Assembly

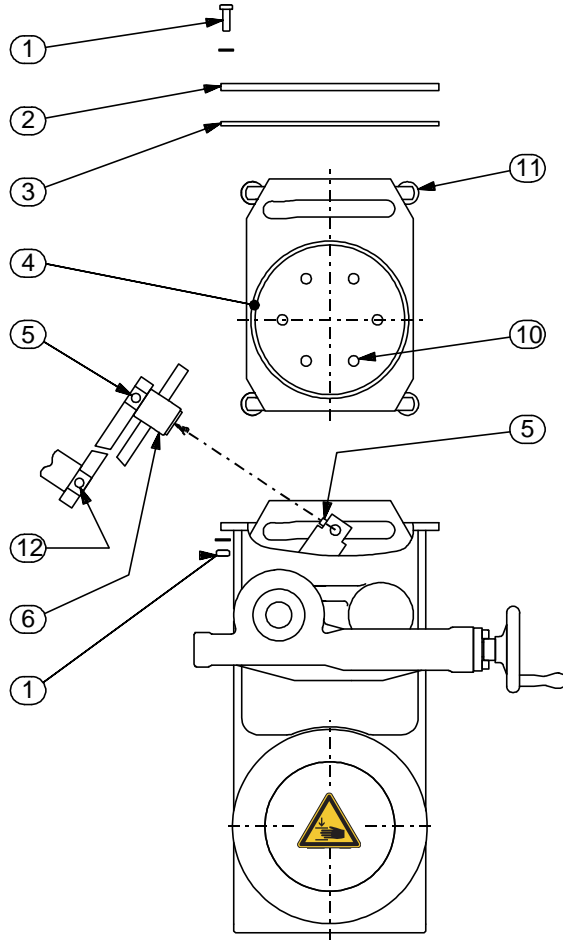

sketch 2

6.2 Mechanism assembly

<p>DN63/100</p> <p>sketch 3</p>	<p>single parts</p> <ol style="list-style-type: none"> 1. Gate O-ring 2. Gate 3. Leaf spring 4. Ball guidance 5. Locking balls 6. Counter dink screw 7. Leaf spring 8. Holding ring 9. Divided ring
<p>DN160/200</p> <p>sketch 4</p>	<p>single parts</p> <ol style="list-style-type: none"> 1. Gate O-ring 2. Gate 3. Leaf spring 4. Ball guidance 5. Locking balls 6. Leaf spring 7. Counter plate 8. Adjusting plate (do not loosen)

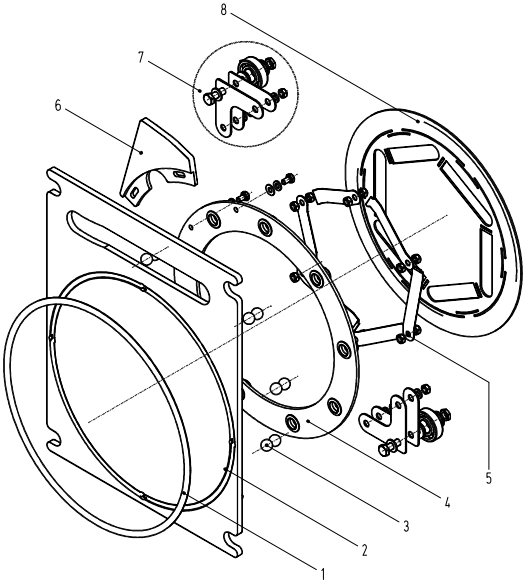
<p>DN250</p>  <p>sketch 5</p>	<p>Single parts</p> <ol style="list-style-type: none"> 1. Gate O-ring 2. Plate 3. Locking balls 4. Ball guidance 5. Leaf spring 6. Adjusting plate (do not loosen) 7. Leaf spring with ball bearing 8. Counter plate
--	---

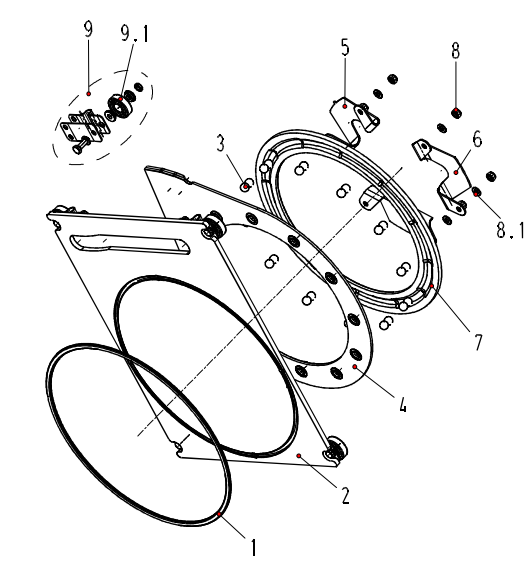
<p>DN320</p>  <p>sketch 6</p>	<p>Single parts</p> <ol style="list-style-type: none"> 1 Gate O-ring 2 Plate 3 Locking balls 4 Ball guidance 5 Leaf spring with adjusting nose 6 Leaf spring 7 Adjusting ring 8 Safety nut 8.1 Washer 9 Leaf spring with ball bearing 9.1 Ball bearing
--	---



Installation, Operating, and Maintenance Instructions
Series 14, DN 63 - 400 (I.D. 2 1/2 - 16")

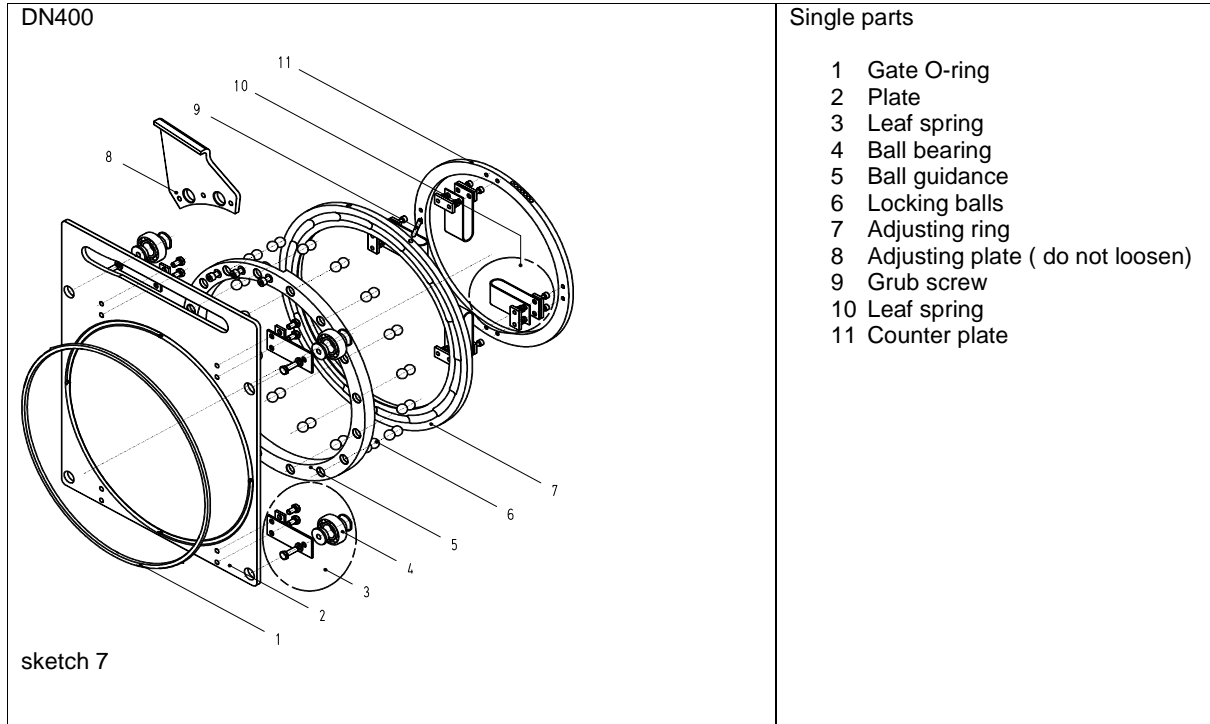

7 Spare parts



Please specify the **fabrication number of the valve** (see yellow label on valve) when ordering spare parts. This is to ensure that the appropriate spare parts are supplied.

The numbers in brackets are referring to drawing in chapter 6.1

Item	description	Order-number									
		DN	63	80	100	160	200	250	320	350	400
	Mechanism complete		89146-R1	219967	94842-R1	84275-R1	84608-R1	83481-R1	209812	209812	215561
	Seal kit ¹⁾		97442-R1	225315	97446-R1	95944-R1	95939-R1	98472-R1	98474-R1	98474-R1	98476-R1
2	Bonnet cover		77776-01	77776-01	77779-01	77782-01	77785-01	87334-01	87335-01	87335-01	87336-01
3	Bonnet seal		77775-R1	77775-R1	77778-R1	77781-R1	77784-R1	N-5100-378	N-5100-382	N-5100-382	N-5100-383
4	Gate seal		N-5102-340	220113	N-5102-351	N-5102-364	N-5102-372	N-5102-453	N-5102-457	N-5102-457	N-5100-461
6	Crank bolt complete ²⁾		205048	205048	205048	205048	205048	205049	205049	205049	205051
7	Position indicator		60546-R1	60546-R1	60546-R1	60546-R1	60546-R1	60546-R1	60546-R1	60546-R1	60546-R1
8	Solenoid ³⁾		N-7501-501	N-7501-501	N-7501-501	N-7501-501	N-7501-501	N-7501-501	N-7501-501	N-7501-501	N-7501-501
10	1 spare kit locking balls (lubricated)		98440-R1	98440-R1	98441-R1	98442-R1	95121-R1	98443-R1	98444-R1	98444-R1	98445-R1
11	1 leaf spring complete [...] quantity per valve ↓		66856-R1 [1 pc]	66856-R1 [1 pc]	67064-R1 [2 pc]	84326-R1 [2 pc]	80642-R1 [2 pc]	99205-R1 [4 pc] ⁴⁾	99205-R1 [4 pc] ⁴⁾	99205-R1 [4 pc] ⁴⁾	77286-01 [4 pc] ⁴⁾
12	Dowel pin		N-6097-478	N-6097-509	N-6097-478	N-6097-480	N-6097-480	N-6097-509	N-6097-509	N-6097-509	N-6097-509

Table 3

¹⁾ Seal kit consist of Item. 3, 4, 13 & 14 according to chapter 6.1 (standard material is Viton)

²⁾ Item. 5 is enclosed to *crank bolt complete*

³⁾ Inform about voltage!!

⁴⁾ DN250 to DN400 only ball bearing without leaf spring

VAT Vakuumventile AG shows its willingness to take over servicing your valve. For that please contact the next VAT representative responsible for your country. Delivery and maintenance will be done in one of our service centres in Haag (Switzerland), in Woburn (USA) or in Ako (Japan).

Always use  lubricated spares !



8 Warranty

Each product sold by VAT Vakuumventile AG (VAT) is warranted to be free from the manufacturing defects that adversely affect the normal functioning thereof during the warranty period stated in VAT's «Terms of Sale» immediately following delivery thereof by VAT, provided that the same is properly operated under conditions of normal use and that regular, periodic maintenance and service is performed or replacements made, in accordance with the instructions provided by VAT. The foregoing warranty shall not apply to any product or component that has been repaired or altered by anyone other than an authorized VAT representative or that has been subject to improper installation or abuse, misuse, negligence or accident. VAT shall not be liable for any damage, loss, or expense, whether consequential, special, incidental, direct or otherwise, caused by, arising out of or connected with the manufacture, delivery (including any delay in or failure to deliver), packaging, storage or use of any product sold or delivered by VAT shall fail to conform to the foregoing warranty or to the description thereof contained herein, the purchaser thereof, as its exclusive remedy, shall upon prompt notice to VAT of any such defect or failure and upon the return of the product, part or component in question to VAT at its factory, with transportation charges prepaid, and upon VAT's inspection confirming the existence of any defect inconsistent with said warranty or any such failure, be entitled to have such defect or failure cured at VAT's factory and at no charge therefor, by replacement or repair of said product, as VAT may elect. VAT MAKES NO WARRANTY OR REPRESENTATION OF ANY KIND, EXPRESS OR IMPLIED, (INCLUDING NO WARRANTY OR MERCHANTABILITY), EXCEPT FOR THE FOREGOING WARRANTY AND THE WARRANTY THAT EACH PRODUCT SHALL CONFORM TO THE DESCRIPTION THEREOF CONTAINED HEREIN, and no warranty shall be implied by law.

Furthermore, the «Terms of sale» at the back of the price list are applicable.